

THE ORIGINAL HYBRID CYLINDRICAL CEILING FAN EVER CREATED.



POINT ONE
TECHNOLOGY

GUST

VERSION/SPECIFICATION

VSPEC-IV

HIGH-PERFORMANCE CEILING FAN



Edition 4.1

VERSION/SPECIFICATION

VSPEC-IV

THE SHORTEST CEILING FAN EVER.

Visit www.pointonetechnology.com for more CFDs information.

POINT ONE
TECHNOLOGY

GUST

VERSION/SPECIFICATION

VSPEC-IV

RIGID ROD MOUNT

Bracket mounting system is further strengthened for stability during high-speed rotation

1.

A.B.S COMPOSITION

ABS plastic has outstanding impact resistance strength and good electrical insulating qualities. It can endure physical impacts and maintain durability under pressure due to combination of styrene and butadiene in it

4.

SILICONE BODYWORK

High tensile strength and sound dampening capability

2.

3.

DEVIATED INCLINE ANGLE

CFD redesigned to enhance aero-efficiency and create powerful air draft

5.

OSRAM GmbH. LIGHT KIT

All-new heat dissipation mechanism with enlarged surface area for heightened longevity and brightness

THE SHORTEST CEILING FAN EVER CREATED YET.

VERSION/SPECIFICATION
VSPEC-IV

NEO-DRIVE

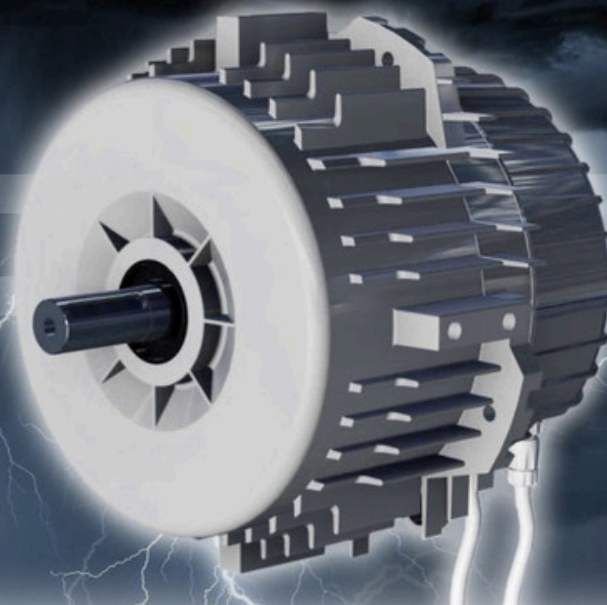

38 Watts
MAX POWER

5 Watts
MIN POWER

240 VOLTS
INPUT

MOTOR CLASS:
EC-CLASS

INPUT:
110-240V

MANUFACTURER:
NSK Ltd.

MAGNET TYPE:
PERMANENT

POWER:
5-38W

BALL BEARING:
CERAMIC

CONTROL UNIT:
DRIVER

MOTOR PLATFORM:
NEO-DRIVE TURBO

CONVERTER:
BRUSHLESS

NSK

POINT ONE
TECHNOLOGY

BRAND NEW EC-CLASS **NEO-DRIVE** MOTOR.

VERSION/SPECIFICATION
VSPEC-IV

NEGATIVE



26 Watts
MAX POWER

2 Watts
MIN POWER

2600 LUMENS
BRIGHTNESS

LUMINAIRE:
LED

DIMMABILITY:
1-100%

MANUFACTURER:
OSRAM GmbH.

TYPE:
SURFACE MOUNTED DEVICES

POWER:
1-26W

CHIP COUNT:
242

CHIP CODE:
3014

BRIGHTNESS:
100-2600Lm

LONGEVITY:
50,000H

BRAND NEW **ULTRA BRIGHT** LIGHT KIT.

POINT ONE
TECHNOLOGY

OSRAM

WIND STRENGTH



7/10

QUIETNESS



7/10



COMPETITION WHITE CASING + WHITE CYLINDER + COMPETITION WHITE OI BLADE

SGD \$469.00

[Price includes Wifi Module]

OSRAM GmbH Light Kit +\$80.00

POINT ONE TECHNOLOGY



The ratings for wind strength and quietness are based on VSPEC-IV specifications and should not be used in comparison with VSPEC-II/III

WIND STRENGTH



7/10

QUIETNESS



7/10



COMPETITION WHITE CASING + WHITE CYLINDER + CARBON BLACK OI BLADE

SGD \$469.00

[Price includes Wifi Module]

OSRAM GmbH Light Kit +\$80.00

POINT ONE
TECHNOLOGY



The ratings for wind strength and quietness are based on VSPEC-IV specifications and should not be used in comparison with VSPEC-II/III

WIND STRENGTH



7/10

QUIETNESS



7/10



COMPETITION WHITE CASING + WHITE CYLINDER + CHERRYWOOD OI BLADE

SGD \$469.00

[Price includes Wifi Module]

OSRAM GmbH Light Kit +\$80.00

POINT ONE
TECHNOLOGY



The ratings for wind strength and quietness are based on VSPEC-IV specifications and should not be used in comparison with VSPEC-II/III

WIND STRENGTH



QUIETNESS



COMPETITION WHITE CASING + WHITE CYLINDER + TIMBER 01 BLADE

SGD \$469.00

[Price includes Wifi Module]

OSRAM GmbH Light Kit +\$80.00

POINT ONE
TECHNOLOGY



The ratings for wind strength and quietness are based on VSPEC-IV specifications and should not be used in comparison with VSPEC-II/III

WIND STRENGTH



QUIETNESS



COPPER BRONZE CASING + WHITE CYLINDER + COMPETITION WHITE O1 BLADE

SGD \$469.00

[Price includes Wifi Module]

OSRAM GmbH Light Kit +\$80.00

POINT ONE
TECHNOLOGY



The ratings for wind strength and quietness are based on VSPEC-IV specifications and should not be used in comparison with VSPEC-II/III

WIND STRENGTH



7/10

QUIETNESS



7/10



COPPER BRONZE CASING + WHITE CYLINDER + CARBON BLACK 01 BLADE

SGD \$469.00

[Price includes Wifi Module]

OSRAM GmbH Light Kit +\$80.00

POINT ONE
TECHNOLOGY



The ratings for wind strength and quietness are based on VSPEC-IV specifications and should not be used in comparison with VSPEC-II/III

WIND STRENGTH



7/10

QUIETNESS



7/10



COPPER BRONZE CASING + WHITE CYLINDER + CHERRYWOOD 01 BLADE

SGD \$469.00

[Price includes Wifi Module]

OSRAM GmbH Light Kit +\$80.00

POINT ONE
TECHNOLOGY



The ratings for wind strength and quietness are based on VSPEC-IV specifications and should not be used in comparison with VSPEC-II/III

WIND STRENGTH



QUIETNESS



COPPER BRONZE CASING + WHITE CYLINDER + TIMBER 01 BLADE

SGD \$469.00

[Price includes Wifi Module]

OSRAM GmbH Light Kit +\$80.00

POINT ONE
TECHNOLOGY



The ratings for wind strength and quietness are based on VSPEC-IV specifications and should not be used in comparison with VSPEC-II/III

WIND STRENGTH



QUIETNESS



ALUMINUM SILVER CASING + WHITE CYLINDER + COMPETITION WHITE O1 BLADE

SGD \$469.00

[Price includes Wifi Module]

OSRAM GmbH Light Kit +\$80.00

POINT ONE
TECHNOLOGY



The ratings for wind strength and quietness are based on VSPEC-IV specifications and should not be used in comparison with VSPEC-II/III

WIND STRENGTH



7/10

QUIETNESS



7/10



ALUMINUM SILVER CASING + WHITE CYLINDER + CARBON BLACK O1 BLADE

SGD \$469.00

[Price includes Wifi Module]

OSRAM GmbH Light Kit +\$80.00

POINT ONE
TECHNOLOGY



38"



46"



54"

The ratings for wind strength and quietness are based on VSPEC-IV specifications and should not be used in comparison with VSPEC-II/III

WIND STRENGTH



7/10

QUIETNESS



7/10



ALUMINUM SILVER CASING + WHITE CYLINDER + CHERRYWOOD 01 BLADE

SGD \$469.00

[Price includes Wifi Module]

OSRAM GmbH Light Kit +\$80.00

POINT ONE
TECHNOLOGY



38"



46"



54"

The ratings for wind strength and quietness are based on VSPEC-IV specifications and should not be used in comparison with VSPEC-II/III

WIND STRENGTH



QUIETNESS



ALUMINUM SILVER CASING + WHITE CYLINDER + TIMBER 01 BLADE

SGD \$469.00

[Price includes Wifi Module]

OSRAM GmbH Light Kit +\$80.00

POINT ONE
TECHNOLOGY



The ratings for wind strength and quietness are based on VSPEC-IV specifications and should not be used in comparison with VSPEC-II/III

WIND STRENGTH



QUIETNESS



CARBON BLACK CASING + BLACK CYLINDER + COMPETITION WHITE OI BLADE

SGD \$469.00

[Price includes Wifi Module]

OSRAM GmbH Light Kit +\$80.00

POINT ONE
TECHNOLOGY



The ratings for wind strength and quietness are based on VSPEC-IV specifications and should not be used in comparison with VSPEC-II/III

WIND STRENGTH



7/10

QUIETNESS



7/10



CARBON BLACK CASING + BLACK CYLINDER + CARBON BLACK 01 BLADE

SGD \$469.00

[Price includes Wifi Module]

OSRAM GmbH Light Kit +\$80.00

POINT ONE
TECHNOLOGY



38"



46"



54"

The ratings for wind strength and quietness are based on VSPEC-IV specifications and should not be used in comparison with VSPEC-II/III

WIND STRENGTH



QUIETNESS



CARBON BLACK CASING + BLACK CYLINDER + CHERRYWOOD 01 BLADE

SGD \$469.00

[Price includes Wifi Module]

OSRAM GmbH Light Kit +\$80.00

POINT ONE
TECHNOLOGY



The ratings for wind strength and quietness are based on VSPEC-IV specifications and should not be used in comparison with VSPEC-II/III

WIND STRENGTH



7/10

QUIETNESS



7/10



CARBON BLACK CASING + BLACK CYLINDER + TIMBER 01 BLADE

SGD \$469.00

[Price includes Wifi Module]

OSRAM GmbH Light Kit +\$80.00

POINT ONE
TECHNOLOGY



38"



46"



54"

The ratings for wind strength and quietness are based on VSPEC-IV specifications and should not be used in comparison with VSPEC-II/III

WIND STRENGTH



QUIETNESS

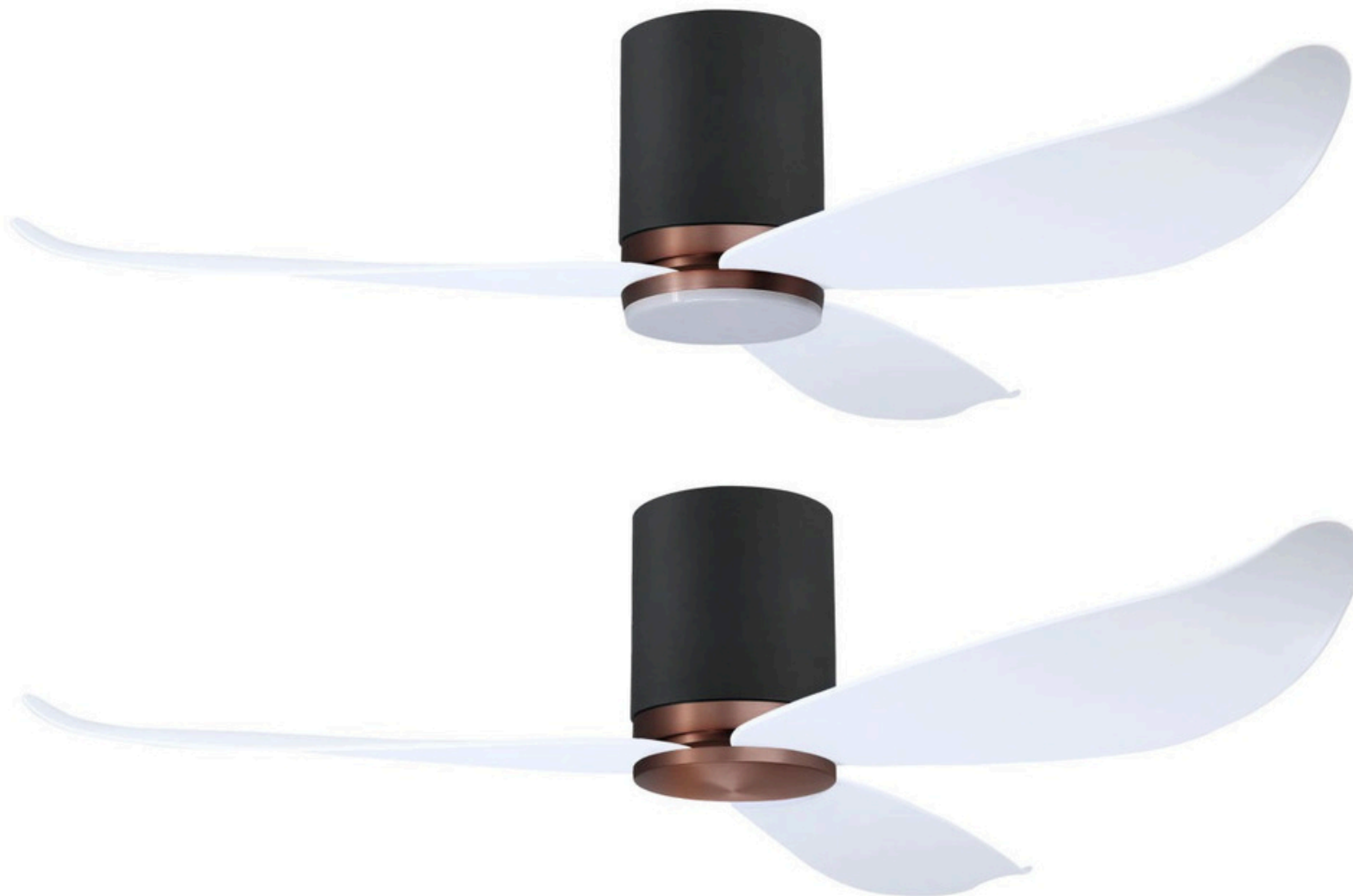

COPPER BRONZE CASING + BLACK CYLINDER + COMPETITION WHITE OI BLADE

SGD \$469.00

[Price includes Wifi Module]

OSRAM GmbH Light Kit +\$80.00

POINT ONE
TECHNOLOGY



The ratings for wind strength and quietness are based on VSPEC-IV specifications and should not be used in comparison with VSPEC-II/III

WIND STRENGTH



QUIETNESS



COPPER BRONZE CASING + BLACK CYLINDER + CARBON BLACK O1 BLADE

SGD \$469.00

[Price includes Wifi Module]

OSRAM GmbH Light Kit +\$80.00

POINT ONE
TECHNOLOGY



The ratings for wind strength and quietness are based on VSPEC-IV specifications and should not be used in comparison with VSPEC-II/III

WIND STRENGTH



7/10

QUIETNESS



7/10



COPPER BRONZE CASING + BLACK CYLINDER + CHERRYWOOD 01 BLADE

SGD \$469.00

[Price includes Wifi Module]

OSRAM GmbH Light Kit +\$80.00

POINT ONE
TECHNOLOGY



38"



46"



54"

The ratings for wind strength and quietness are based on VSPEC-IV specifications and should not be used in comparison with VSPEC-II/III

WIND STRENGTH



7/10

QUIETNESS



7/10



COPPER BRONZE CASING + BLACK CYLINDER + TIMBER 01 BLADE

SGD \$469.00

[Price includes Wifi Module]

OSRAM GmbH Light Kit +\$80.00

POINT ONE
TECHNOLOGY



38"



46"



54"

The ratings for wind strength and quietness are based on VSPEC-IV specifications and should not be used in comparison with VSPEC-II/III

WIND STRENGTH



QUIETNESS



ALUMINUM SILVER CASING + BLACK CYLINDER + COMPETITION WHITE OI BLADE

SGD \$469.00

[Price includes Wifi Module]

OSRAM GmbH Light Kit +\$80.00

POINT ONE
TECHNOLOGY



The ratings for wind strength and quietness are based on VSPEC-IV specifications and should not be used in comparison with VSPEC-II/III

WIND STRENGTH



QUIETNESS



ALUMINUM SILVER CASING + BLACK CYLINDER + CARBON BLACK O1 BLADE

SGD \$469.00

[Price includes Wifi Module]

OSRAM GmbH Light Kit +\$80.00

POINT ONE
TECHNOLOGY



The ratings for wind strength and quietness are based on VSPEC-IV specifications and should not be used in comparison with VSPEC-II/III

WIND STRENGTH



7/10

QUIETNESS



7/10



ALUMINUM SILVER CASING + BLACK CYLINDER + CHERRYWOOD 01 BLADE

SGD \$469.00

[Price includes Wifi Module]

OSRAM GmbH Light Kit +\$80.00

POINT ONE
TECHNOLOGY



The ratings for wind strength and quietness are based on VSPEC-IV specifications and should not be used in comparison with VSPEC-II/III

WIND STRENGTH



7/10

QUIETNESS



7/10



ALUMINUM SILVER CASING + BLACK CYLINDER + TIMBER 01 BLADE

SGD \$469.00

[Price includes Wifi Module]

OSRAM GmbH Light Kit +\$80.00

POINT ONE
TECHNOLOGY



The ratings for wind strength and quietness are based on VSPEC-IV specifications and should not be used in comparison with VSPEC-II/III

WIND STRENGTH



7/10

QUIETNESS



7/10



COMPETITION WHITE CASING + WHITE CYLINDER + COMPETITION WHITE 06 BLADE

SGD \$469.00

[Price includes Wifi Module]

OSRAM GmbH Light Kit +\$80.00

POINT ONE
TECHNOLOGY



The ratings for wind strength and quietness are based on VSPEC-IV specifications and should not be used in comparison with VSPEC-II/III

WIND STRENGTH



QUIETNESS



COMPETITION WHITE CASING + WHITE CYLINDER + CARBON BLACK 06 BLADE

SGD \$469.00

[Price includes Wifi Module]

OSRAM GmbH Light Kit +\$80.00

POINT ONE
TECHNOLOGY



The ratings for wind strength and quietness are based on VSPEC-IV specifications and should not be used in comparison with VSPEC-II/III

WIND STRENGTH



QUIETNESS



COMPETITION WHITE CASING + WHITE CYLINDER + CHERRYWOOD 06 BLADE

SGD \$469.00

[Price includes Wifi Module]

OSRAM GmbH Light Kit +\$80.00

POINT ONE
TECHNOLOGY



The ratings for wind strength and quietness are based on VSPEC-IV specifications and should not be used in comparison with VSPEC-II/III

WIND STRENGTH



QUIETNESS



COMPETITION WHITE CASING + WHITE CYLINDER + GREYWOOD 06 BLADE

SGD \$469.00

[Price includes Wifi Module]

OSRAM GmbH Light Kit +\$80.00

POINT ONE
TECHNOLOGY



The ratings for wind strength and quietness are based on VSPEC-IV specifications and should not be used in comparison with VSPEC-II/III

WIND STRENGTH



QUIETNESS



COPPER BRONZE CASING + WHITE CYLINDER + COMPETITION WHITE 06 BLADE

SGD \$469.00

[Price includes Wifi Module]

OSRAM GmbH Light Kit +\$80.00

POINT ONE
TECHNOLOGY



The ratings for wind strength and quietness are based on VSPEC-IV specifications and should not be used in comparison with VSPEC-II/III

WIND STRENGTH



QUIETNESS



COPPER BRONZE CASING + WHITE CYLINDER + CARBON BLACK 06 BLADE

SGD \$469.00

[Price includes Wifi Module]

OSRAM GmbH Light Kit +\$80.00

POINT ONE
TECHNOLOGY



The ratings for wind strength and quietness are based on VSPEC-IV specifications and should not be used in comparison with VSPEC-II/III

WIND STRENGTH



QUIETNESS



COPPER BRONZE CASING + WHITE CYLINDER + CHERRYWOOD 06 BLADE

SGD \$469.00

[Price includes Wifi Module]

OSRAM GmbH Light Kit +\$80.00

POINT ONE
TECHNOLOGY



The ratings for wind strength and quietness are based on VSPEC-IV specifications and should not be used in comparison with VSPEC-II/III

WIND STRENGTH



QUIETNESS



COPPER BRONZE CASING + WHITE CYLINDER + GREYWOOD 06 BLADE

SGD \$469.00

[Price includes Wifi Module]

OSRAM GmbH Light Kit +\$80.00

POINT ONE
TECHNOLOGY



The ratings for wind strength and quietness are based on VSPEC-IV specifications and should not be used in comparison with VSPEC-II/III

WIND STRENGTH



QUIETNESS



CARBON BLACK CASING + BLACK CYLINDER + COMPETITION WHITE 06 BLADE

SGD \$469.00

[Price includes Wifi Module]

OSRAM GmbH Light Kit +\$80.00

POINT ONE
TECHNOLOGY



The ratings for wind strength and quietness are based on VSPEC-IV specifications and should not be used in comparison with VSPEC-II/III

WIND STRENGTH



QUIETNESS



CARBON BLACK CASING + BLACK CYLINDER + CARBON BLACK 06 BLADE

SGD \$469.00

[Price includes Wifi Module]

OSRAM GmbH Light Kit +\$80.00

POINT ONE
TECHNOLOGY



The ratings for wind strength and quietness are based on VSPEC-IV specifications and should not be used in comparison with VSPEC-II/III

WIND STRENGTH



QUIETNESS



CARBON BLACK CASING + BLACK CYLINDER + CHERRYWOOD 06 BLADE

SGD \$469.00

[Price includes Wifi Module]

OSRAM GmbH Light Kit +\$80.00

POINT ONE
TECHNOLOGY



The ratings for wind strength and quietness are based on VSPEC-IV specifications and should not be used in comparison with VSPEC-II/III

WIND STRENGTH



QUIETNESS



CARBON BLACK CASING + BLACK CYLINDER + GREYWOOD 06 BLADE

SGD \$469.00

[Price includes Wifi Module]

OSRAM GmbH Light Kit +\$80.00

POINT ONE
TECHNOLOGY



The ratings for wind strength and quietness are based on VSPEC-IV specifications and should not be used in comparison with VSPEC-II/III

WIND STRENGTH



QUIETNESS

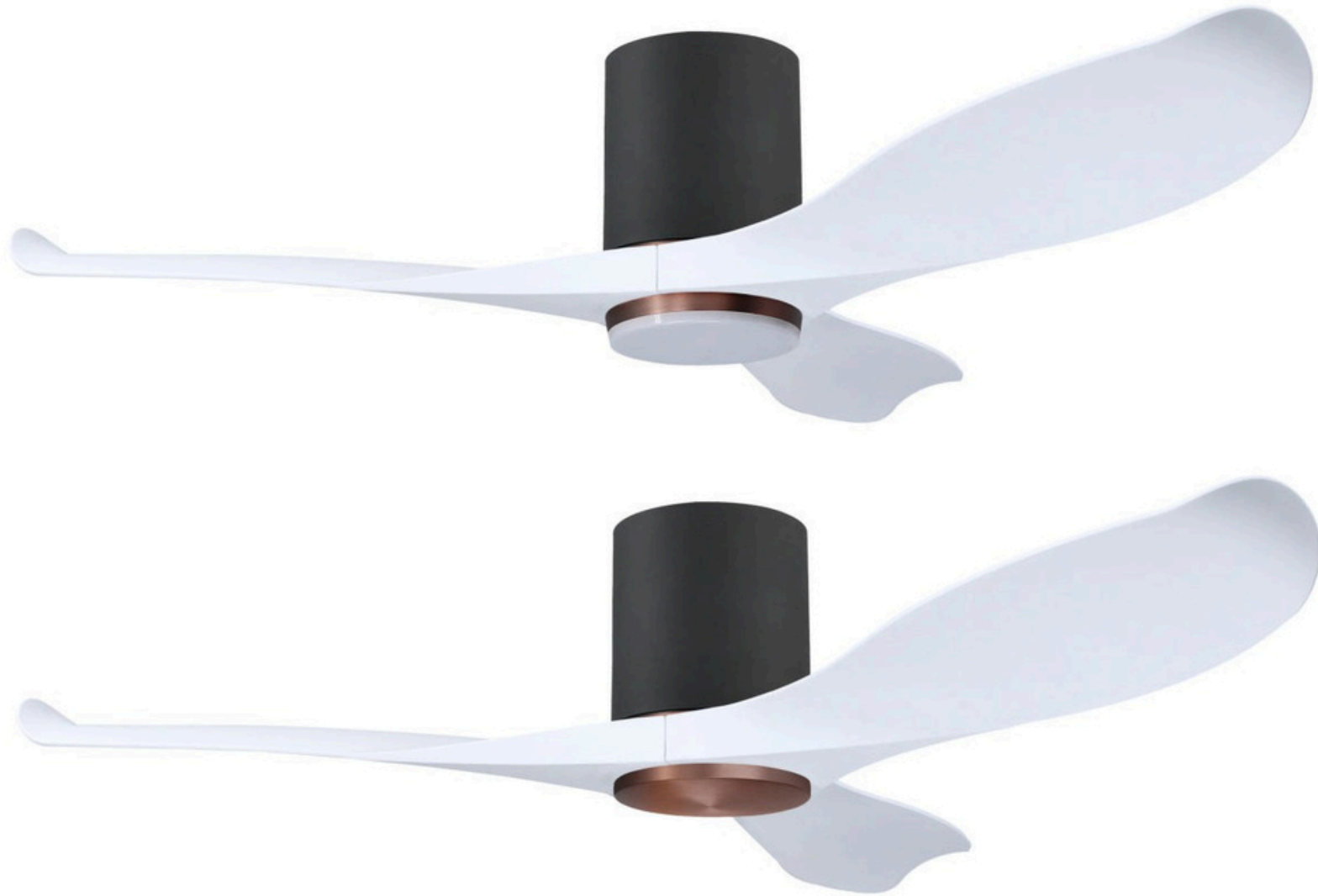

COPPER BRONZE CASING + BLACK CYLINDER + COMPETITION WHITE 06 BLADE

SGD \$469.00

[Price includes Wifi Module]

OSRAM GmbH Light Kit +\$80.00

POINT ONE
TECHNOLOGY



The ratings for wind strength and quietness are based on VSPEC-IV specifications and should not be used in comparison with VSPEC-II/III

WIND STRENGTH



QUIETNESS



COPPER BRONZE CASING + BLACK CYLINDER + CARBON BLACK 06 BLADE

SGD \$469.00

[Price includes Wifi Module]

OSRAM GmbH Light Kit +\$80.00

POINT ONE
TECHNOLOGY



The ratings for wind strength and quietness are based on VSPEC-IV specifications and should not be used in comparison with VSPEC-II/III

WIND STRENGTH



7/10

QUIETNESS



7/10



COPPER BRONZE CASING + BLACK CYLINDER + CHERRYWOOD 06 BLADE

SGD \$469.00

[Price includes Wifi Module]

OSRAM GmbH Light Kit +\$80.00

POINT ONE
TECHNOLOGY



38"



43"



52"

The ratings for wind strength and quietness are based on VSPEC-IV specifications and should not be used in comparison with VSPEC-II/III

WIND STRENGTH



7/10

QUIETNESS



7/10



COPPER BRONZE CASING + BLACK CYLINDER + GREYWOOD 06 BLADE

SGD \$469.00

[Price includes Wifi Module]

OSRAM GmbH Light Kit +\$80.00

POINT ONE
TECHNOLOGY



The ratings for wind strength and quietness are based on VSPEC-IV specifications and should not be used in comparison with VSPEC-II/III

WIND STRENGTH



5/10

QUIETNESS



10/10



COMPETITION WHITE CASING + WHITE CYLINDER + COMPETITION WHITE 08 BLADE

SGD \$469.00

[Price includes Wifi Module]

OSRAM GmbH Light Kit +\$80.00

POINT ONE
TECHNOLOGY

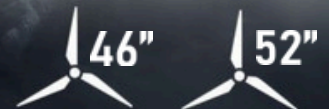

The ratings for wind strength and quietness are based on VSPEC-IV specifications and should not be used in comparison with VSPEC-II/III

WIND STRENGTH



5/10

QUIETNESS



10/10



COMPETITION WHITE CASING + WHITE CYLINDER + CARBON BLACK 08 BLADE

SGD \$469.00

[Price includes Wifi Module]

OSRAM GmbH Light Kit +\$80.00

POINT ONE
TECHNOLOGY

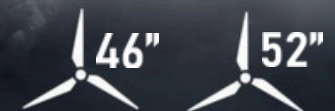

The ratings for wind strength and quietness are based on VSPEC-IV specifications and should not be used in comparison with VSPEC-II/III

WIND STRENGTH



5/10

QUIETNESS



10/10



COMPETITION WHITE CASING + WHITE CYLINDER + CHERRYWOOD 08 BLADE

SGD \$469.00

[Price includes Wifi Module]

OSRAM GmbH Light Kit +\$80.00

POINT ONE
TECHNOLOGY



The ratings for wind strength and quietness are based on VSPEC-IV specifications and should not be used in comparison with VSPEC-II/III

WIND STRENGTH



5/10

QUIETNESS



10/10



COPPER BRONZE CASING + WHITE CYLINDER + COMPETITION WHITE 08 BLADE

SGD \$469.00

[Price includes Wifi Module]

OSRAM GmbH Light Kit +\$80.00

POINT ONE
TECHNOLOGY

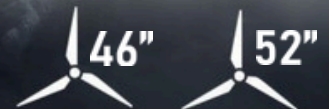

The ratings for wind strength and quietness are based on VSPEC-IV specifications and should not be used in comparison with VSPEC-II/III

WIND STRENGTH



5/10

QUIETNESS



10/10



COPPER BRONZE CASING + WHITE CYLINDER + CARBON BLACK 08 BLADE

SGD \$469.00

[Price includes Wifi Module]

OSRAM GmbH Light Kit +\$80.00

POINT ONE
TECHNOLOGY

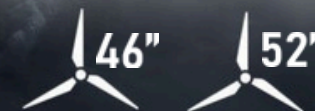

The ratings for wind strength and quietness are based on VSPEC-IV specifications and should not be used in comparison with VSPEC-II/III

WIND STRENGTH



5/10

QUIETNESS



10/10



COPPER BRONZE CASING + WHITE CYLINDER + CHERRYWOOD 08 BLADE

SGD \$469.00

[Price includes Wifi Module]

OSRAM GmbH Light Kit +\$80.00

POINT ONE
TECHNOLOGY



36"



46"



52"

The ratings for wind strength and quietness are based on VSPEC-IV specifications and should not be used in comparison with VSPEC-II/III

WIND STRENGTH



5/10

QUIETNESS



10/10



ALUMINUM SILVER CASING + WHITE CYLINDER + COMPETITION WHITE 08 BLADE

SGD \$469.00

[Price includes Wifi Module]

OSRAM GmbH Light Kit +\$80.00

POINT ONE
TECHNOLOGY

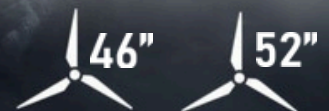

The ratings for wind strength and quietness are based on VSPEC-IV specifications and should not be used in comparison with VSPEC-II/III

WIND STRENGTH



5/10

QUIETNESS



10/10



ALUMINUM SILVER CASING + WHITE CYLINDER + CARBON BLACK 08 BLADE

SGD \$469.00

[Price includes Wifi Module]

OSRAM GmbH Light Kit +\$80.00

POINT ONE
TECHNOLOGY

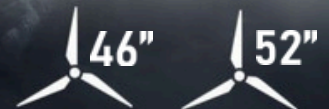

The ratings for wind strength and quietness are based on VSPEC-IV specifications and should not be used in comparison with VSPEC-II/III

WIND STRENGTH



5/10

QUIETNESS



10/10



ALUMINUM SILVER CASING + WHITE CYLINDER + CHERRYWOOD 08 BLADE

SGD \$469.00

[Price includes Wifi Module]

OSRAM GmbH Light Kit +\$80.00

POINT ONE
TECHNOLOGY



The ratings for wind strength and quietness are based on VSPEC-IV specifications and should not be used in comparison with VSPEC-II/III

WIND STRENGTH



5/10

QUIETNESS



10/10

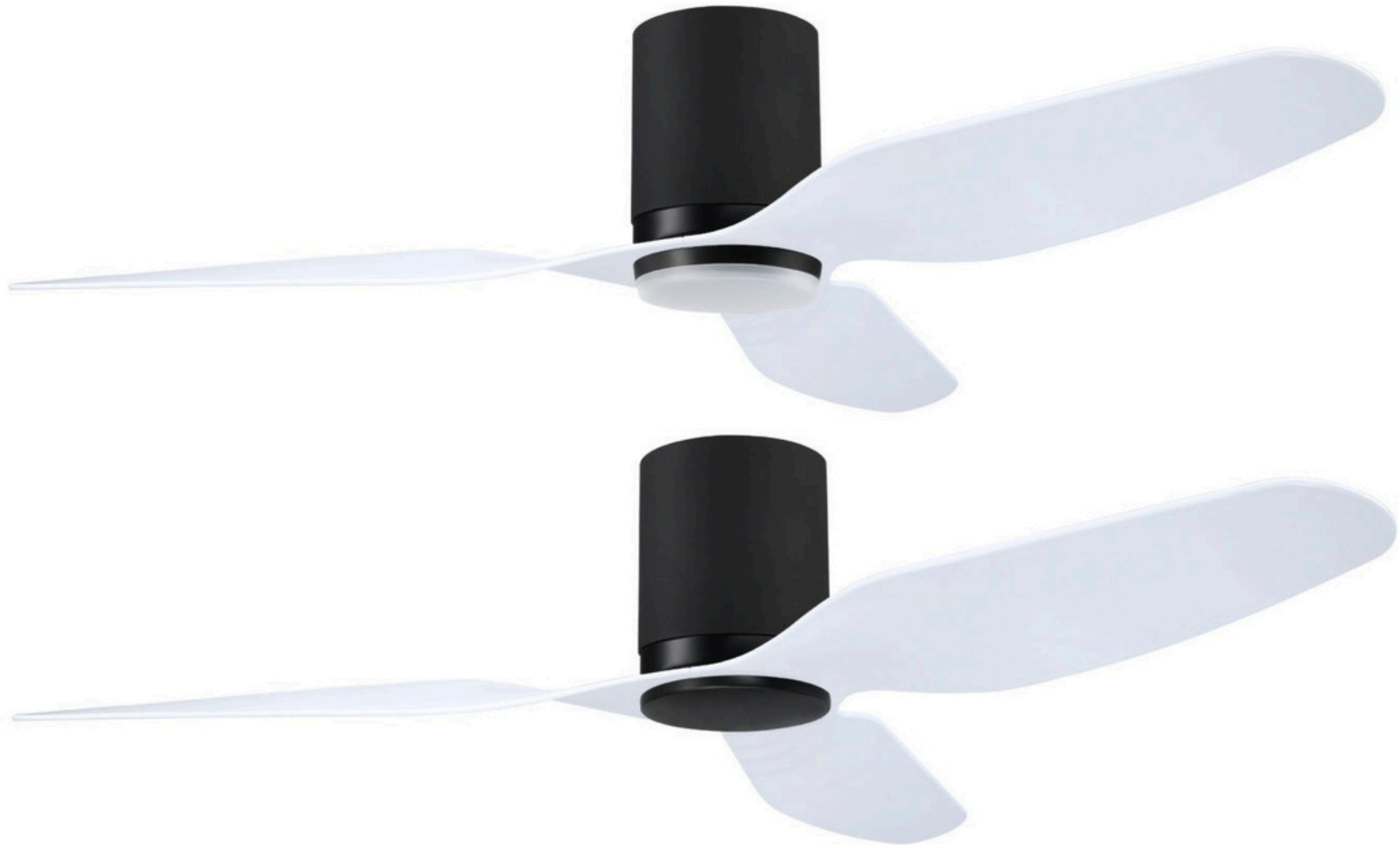

CARBON BLACK CASING + BLACK CYLINDER + COMPETITION WHITE 08 BLADE

SGD \$469.00

[Price includes Wifi Module]

OSRAM GmbH Light Kit +\$80.00

POINT ONE
TECHNOLOGY

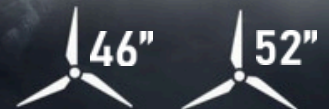

The ratings for wind strength and quietness are based on VSPEC-IV specifications and should not be used in comparison with VSPEC-II/III

WIND STRENGTH



5/10

QUIETNESS



10/10



CARBON BLACK CASING + BLACK CYLINDER + CARBON BLACK 08 BLADE

SGD \$469.00

[Price includes Wifi Module]

OSRAM GmbH Light Kit +\$80.00

POINT ONE
TECHNOLOGY

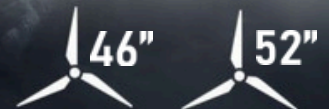

The ratings for wind strength and quietness are based on VSPEC-IV specifications and should not be used in comparison with VSPEC-II/III

WIND STRENGTH



5/10

QUIETNESS



10/10



CARBON BLACK CASING + BLACK CYLINDER + CHERRYWOOD 08 BLADE

SGD \$469.00

[Price includes Wifi Module]

OSRAM GmbH Light Kit +\$80.00

POINT ONE
TECHNOLOGY



The ratings for wind strength and quietness are based on VSPEC-IV specifications and should not be used in comparison with VSPEC-II/III

WIND STRENGTH



5/10

QUIETNESS



10/10



COPPER BRONZE CASING + BLACK CYLINDER + COMPETITION WHITE 08 BLADE

SGD \$469.00

[Price includes Wifi Module]

OSRAM GmbH Light Kit +\$80.00

POINT ONE
TECHNOLOGY

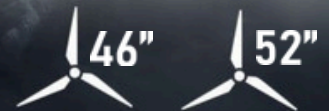

The ratings for wind strength and quietness are based on VSPEC-IV specifications and should not be used in comparison with VSPEC-II/III

WIND STRENGTH



5/10

QUIETNESS



10/10



COPPER BRONZE CASING + BLACK CYLINDER + CARBON BLACK 08 BLADE

SGD \$469.00

[Price includes Wifi Module]

OSRAM GmbH Light Kit +\$80.00

POINT ONE
TECHNOLOGY

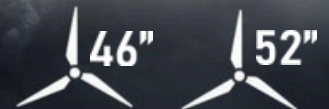

The ratings for wind strength and quietness are based on VSPEC-IV specifications and should not be used in comparison with VSPEC-II/III

WIND STRENGTH



5/10

QUIETNESS



10/10



COPPER BRONZE CASING + BLACK CYLINDER + CHERRYWOOD 08 BLADE

SGD \$469.00

[Price includes Wifi Module]

OSRAM GmbH Light Kit +\$80.00

POINT ONE
TECHNOLOGY



The ratings for wind strength and quietness are based on VSPEC-IV specifications and should not be used in comparison with VSPEC-II/III

WIND STRENGTH



5/10

QUIETNESS



10/10



ALUMINUM SILVER CASING + BLACK CYLINDER + COMPETITION WHITE 08 BLADE

SGD \$469.00

[Price includes Wifi Module]

OSRAM GmbH Light Kit +\$80.00

POINT ONE
TECHNOLOGY

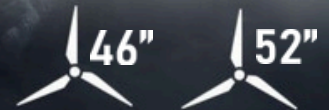

The ratings for wind strength and quietness are based on VSPEC-IV specifications and should not be used in comparison with VSPEC-II/III

WIND STRENGTH



5/10

QUIETNESS



10/10



ALUMINUM SILVER CASING + BLACK CYLINDER + CARBON BLACK 08 BLADE

SGD \$469.00

[Price includes Wifi Module]

OSRAM GmbH Light Kit +\$80.00

POINT ONE
TECHNOLOGY

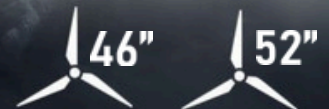

The ratings for wind strength and quietness are based on VSPEC-IV specifications and should not be used in comparison with VSPEC-II/III

WIND STRENGTH



5/10

QUIETNESS



10/10



ALUMINUM SILVER CASING + BLACK CYLINDER + CHERRYWOOD 08 BLADE

SGD \$469.00

[Price includes Wifi Module]

OSRAM GmbH Light Kit +\$80.00

POINT ONE
TECHNOLOGY



The ratings for wind strength and quietness are based on VSPEC-IV specifications and should not be used in comparison with VSPEC-II/III

SPEED-TO-POWER

VERSION/SPECIFICATION IV

AIR POWER DERIVATIVE:

The flow draft value is calculated based on the maximum setting of the ceiling fan. It takes into account of the average diameter of the fan with reference to the velocity per second.

VERSATILITY DERIVATIVE:

The mobility value is computed based on the functionality of the ceiling fan. It takes into account of the possible avenue the ceiling fan can be used for maximum air draft effect.

VARIATION DERIVATIVE:

The customizability value is assessed based on the different sizes and colors available for the ceiling fan.

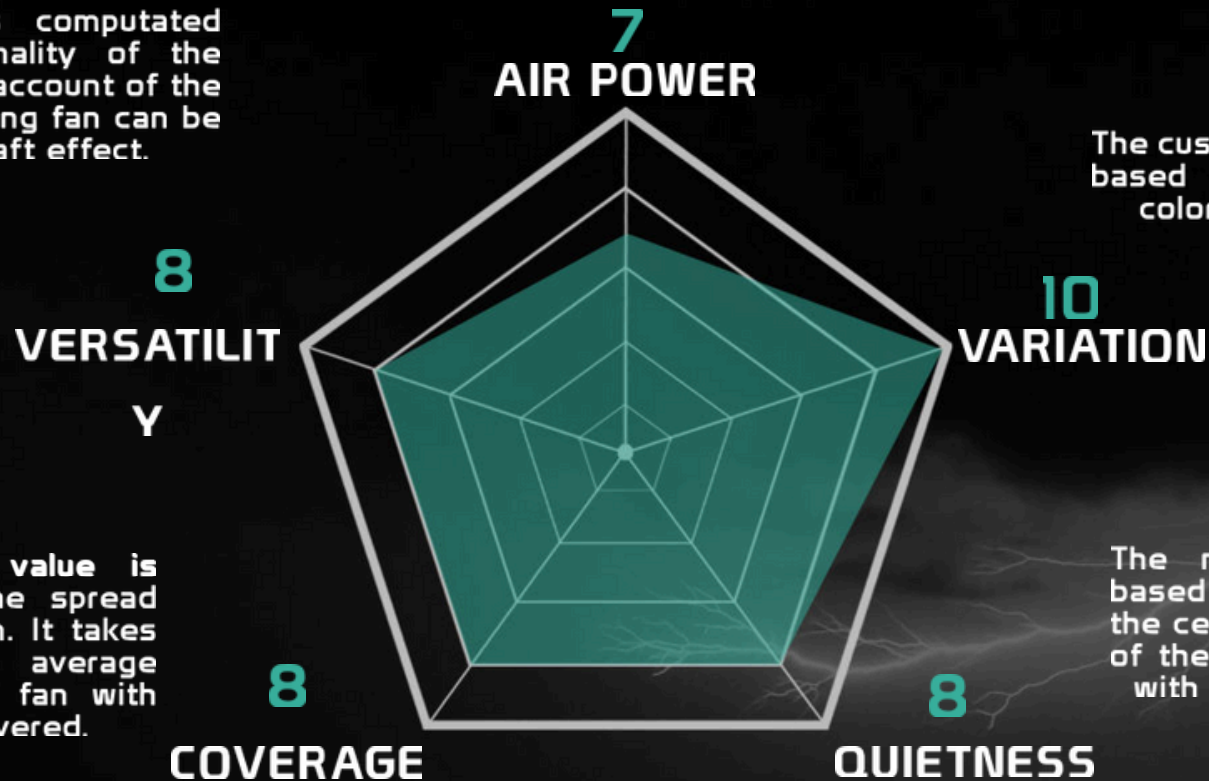

QUIETNESS DERIVATIVE:

The noise value is enumerated based on the maximum setting of the ceiling fan. It takes into account of the average diameter of the fan with reference to the decibel level.

COVERAGE DERIVATIVE:

The area of attack value is quantified based on the spread effect of the ceiling fan. It takes into account of the average diameter of the ceiling fan with reference to the area covered.

SPEED-TO-POWER

VERSION/SPECIFICATION IV

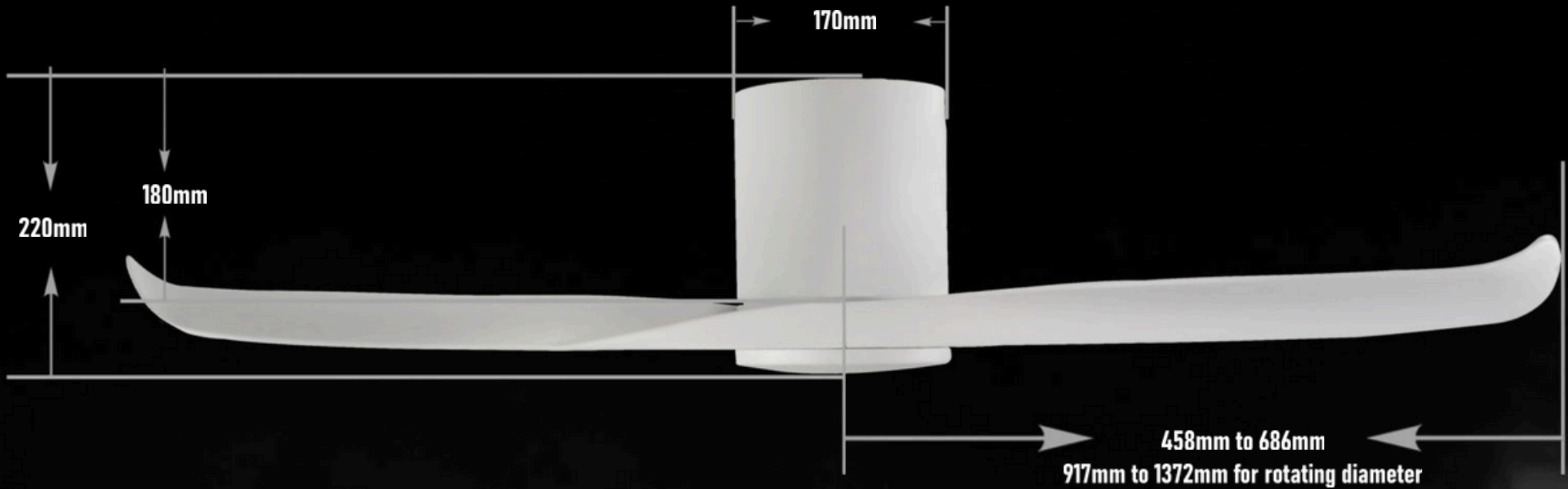

AIR FOIL: 01 [GUST]

GUST VSPEC-IV 01 BLADE 38"

SPEED 1	123 RPM / 6.0 W
SPEED 2	192 RPM / 9.3 W
SPEED 3	240 RPM / 13.3 W
SPEED 4	265 RPM / 17.5 W
SPEED 5	298 RPM / 23.0 W
SPEED 6	315 RPM / 25.0 W

WEIGHT 4.95 Kg

GUST VSPEC-IV 01 BLADE 46"

SPEED 1	141 RPM / 7.2 W
SPEED 2	176 RPM / 9.5 W
SPEED 3	225 RPM / 16.0 W
SPEED 4	247 RPM / 19.8 W
SPEED 5	272 RPM / 25.5 W
SPEED 6	308 RPM / 38.0 W

WEIGHT 5.28 Kg

GUST VSPEC-IV 01 BLADE 54"

SPEED 1	106 RPM / 6.8 W
SPEED 2	129 RPM / 9.3 W
SPEED 3	161 RPM / 15.4 W
SPEED 4	176 RPM / 18.9 W
SPEED 5	195 RPM / 24.5 W
SPEED 6	229 RPM / 38.0 W

WEIGHT 5.66 Kg

SPEED-TO-POWER

VERSION/SPECIFICATION IV

AIR FOIL: 06 [GUST]

GUST VSPEC-IV 06 BLADE 38"

SPEED 1	110 RPM / 6.0 W
SPEED 2	182 RPM / 9.3 W
SPEED 3	229 RPM / 13.3 W
SPEED 4	251 RPM / 17.5 W
SPEED 5	276 RPM / 23.0 W
SPEED 6	301 RPM / 25.0 W

WEIGHT 4.95 Kg

GUST VSPEC-IV 06 BLADE 43"

SPEED 1	127 RPM / 9.2 W
SPEED 2	164 RPM / 14.6 W
SPEED 3	198 RPM / 21.6 W
SPEED 4	223 RPM / 28.2 W
SPEED 5	233 RPM / 33.5 W
SPEED 6	263 RPM / 38.0 W

WEIGHT 5.32 Kg

GUST VSPEC-IV 06 BLADE 52"

SPEED 1	109 RPM / 9.0 W
SPEED 2	133 RPM / 14.0 W
SPEED 3	160 RPM / 21.0 W
SPEED 4	180 RPM / 28.0 W
SPEED 5	190 RPM / 33.0 W
SPEED 6	217 RPM / 38.0 W

WEIGHT 5.75 Kg

AIR FOIL: 08 [GUST]

GUST VSPEC-IV 08 BLADE 36"

SPEED 1	118 RPM / 6.5 W
SPEED 2	178 RPM / 9.3 W
SPEED 3	201 RPM / 13.5 W
SPEED 4	245 RPM / 18.0 W
SPEED 5	283 RPM / 23.5 W
SPEED 6	308 RPM / 38.0 W

WEIGHT 4.88 Kg

GUST VSPEC-IV 08 BLADE 46"

SPEED 1	126 RPM / 9.3 W
SPEED 2	152 RPM / 14.5 W
SPEED 3	190 RPM / 21.7 W
SPEED 4	211 RPM / 28.4 W
SPEED 5	225 RPM / 33.6 W
SPEED 6	255 RPM / 38.0 W

WEIGHT 5.27 Kg

GUST VSPEC-IV 08 BLADE 52"

SPEED 1	112 RPM / 9.0 W
SPEED 2	142 RPM / 14.6 W
SPEED 3	168 RPM / 21.0 W
SPEED 4	197 RPM / 28.0 W
SPEED 5	204 RPM / 33.0 W
SPEED 6	228 RPM / 38.0 W

WEIGHT 5.60 Kg

WARRANTY

VERSION/SPECIFICATION IV



Incl. NSK Ceramic Ball Bearings &
Additional Mechanical Component Wear & Tear

*YOUR HIGH-PERFORMANCE CEILING FAN IS GUARANTEED AGAINST ALL MANUFACTURING DEFECTS
FOR THE FOLLOWING PERIOD STARTING FROM THE DATE OF PURCHASE/INSTALLATION*



Including structural integrity
of the external casing



Including but not limited to
Remote Control & Driver



Including Labor & Transport
(Appl. for Agent Installation only)

AGENT INSTALLATION

CONCRETE CEILING (BELOW 3.0m) :	\$ 50.00
CONCRETE CEILING (BETWEEN 3.0m TO 3.5m) :	\$ 80.00
CONCRETE CEILING (ABOVE 3.5m) :	\$ P.O.A
FALSE CEILING (BELOW 3.0m) :	\$ 150.00
FALSE CEILING (BETWEEN 3.0m TO 3.5m) :	\$ 180.00
FALSE CEILING (ABOVE 3.5m):	\$ P.O.A

THE HIGH-PERFORMANCE NATURE OF POINT ONE TECHNOLOGY MAKES OUR CEILING FANS NO ORDINARY FAN. FROM THE MECHANICAL TO ELECTRICAL COMPONENTS, THEY ARE BUILT TO LAST DECADES. THE COMPREHENSIVE WARRANTY WE PROVIDE BEST SHOWCASE OUR COMMITMENT & TRUST IN MAKING THE BEST CEILING FANS POSSIBLE.

VERSION/SPECIFICATION

VSPEC-IV